

lampada 1055

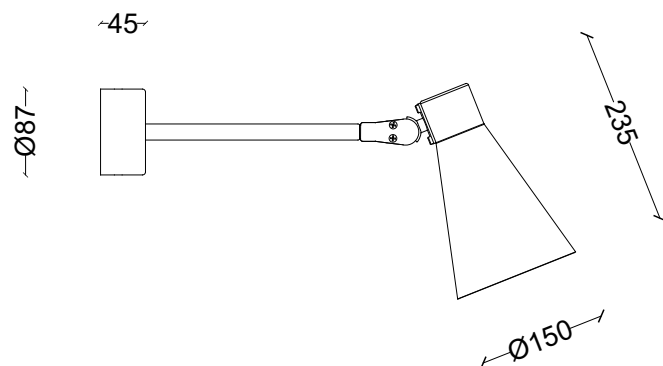

la collezione è interamente realizzata in lamiera di alluminio
con design industriale tipico degli anni '50 e '60
the collection is made entirely of aluminum plate with
industrial design typical of the 1950s and 1960s



descrizione description

caratteristiche description	IN 220/230V-50/60Hz
materiali material	alluminio aluminium
IP	IP 20
portalampada lampholders	E27 ceramico E27 ceramic
fissaggio bracket	parete wall
colori colors	disponibili colori RAL da tabella + anodizzazione rame available RAL colors from table + copper anodizing
cavo di alimentazione power cord	3 x 0,75 m 3 x 0,75 m

dettaglio snodo joint detail

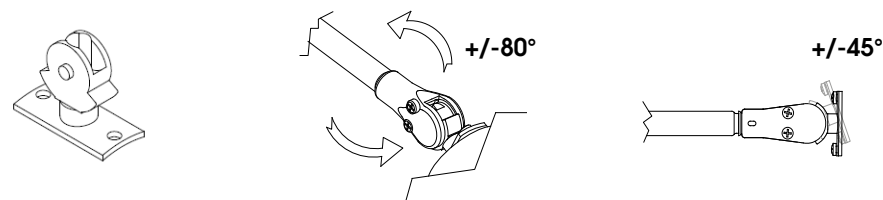

*lampadina non inclusa

*questo dispositivo è compatibile con lampadine di classi energetiche da A++ a D

*lamp not included

*this device is compatible with bulbs in energy classes A++ to D